

Fabricated sheet metal panels and components

We produce all fabricated parts in-house using our state-of-the-art manufacturing facilities which include CNC punching and break press folding machines. Flat sheet aluminum and steel can be punched with any number of holes or series of slots to produce special front panels, covers, tops and base panels for our enclosures. Fully bespoke enclosures and sheet metal parts can also be fabricated to your design using these processes. We work to your drawings and specifications.

See below for a full stock list of sheet metal materials and standard hole punches we have available:

Options available:

- CNC punching of holes, slots, half shears, dimples, burst holes, vent louvres
- CNC folding of corners, tabs, flanges, dutch folds, joggles
- Fitting of inserts, PCB pillars, threaded studs, earth tags
- Linishing of aluminum panels for a blemish free finish.

Use the [contact form](#) or call our sales team on (800) 965-9872 for more information and a quotation.

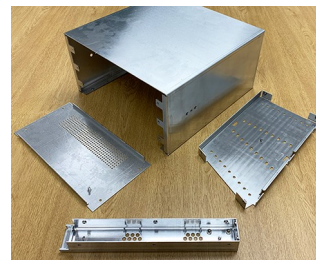
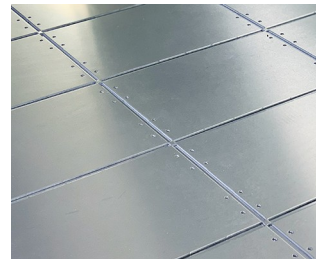
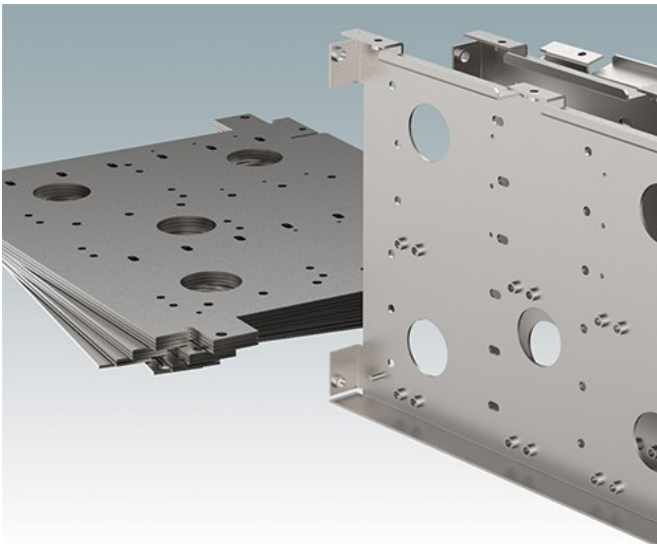

Select Versions

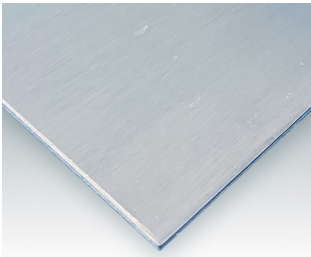

M0000600
Aluminum Sheet
Aluminum
Natural finish



M0000601
Aluminum Sheet
Aluminum
PVC protection film

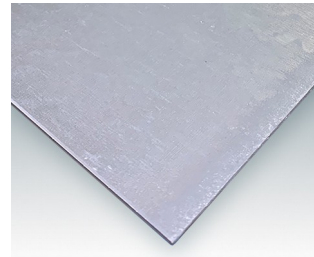

M0000650
Mild Steel Sheet, Galvanized
Mild Steel Galvanized
Galvanized



M0000651
Mild Steel Sheet, Galvanized
Mild Steel Galvanized
Galvanized

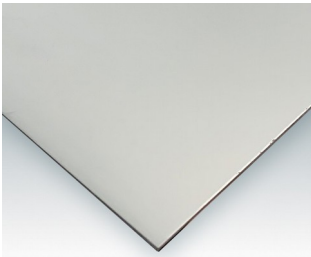

M0000652
Mild Steel Sheet, Zintec
Mild Steel Zintec
Zinc coated

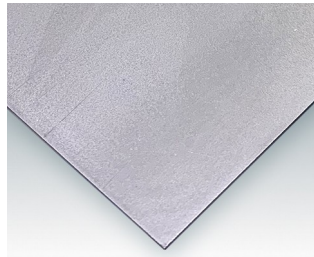

M0000653
Mild Steel Sheet CR4
Mild Steel CR4
Natural finish

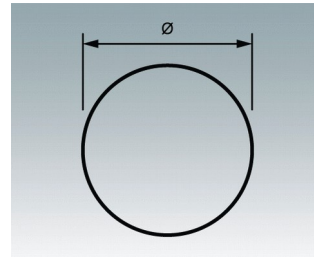

M0000800
Round Cutout
Punch Tools

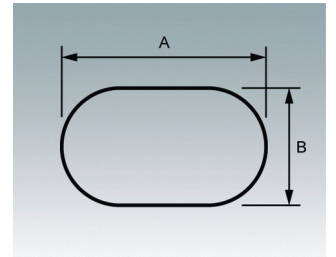

M0000801
Obround Cutout
Punch Tools

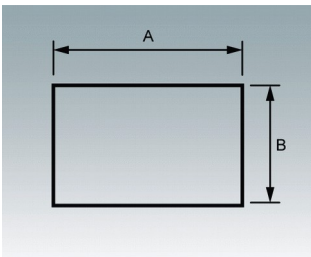

M0000802
Rectangular Cutout
Punch Tools

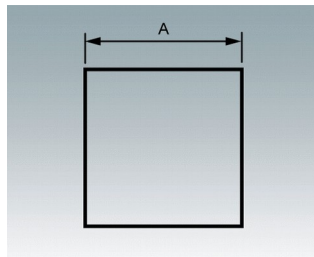

M0000803
Square Cutout
Punch Tools

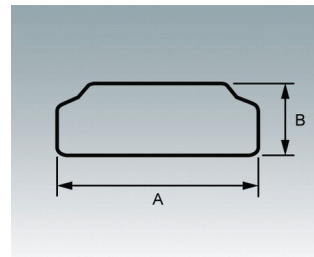

M0000804
HDMI Cutout
Punch Tools

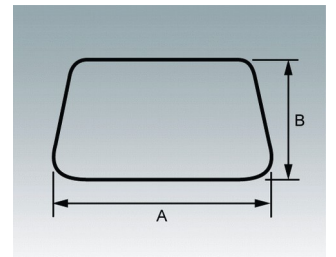

M0000805
D-SUB Cutout
Punch Tools

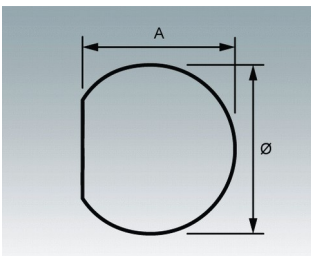

M0000806
SD Cutout
Punch Tools

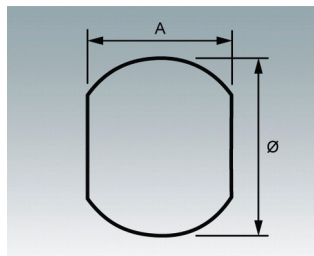

M0000807
DD Cutout
Punch Tools

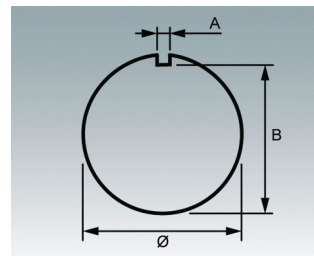

M0000808
Keyway Cutout
Punch Tools

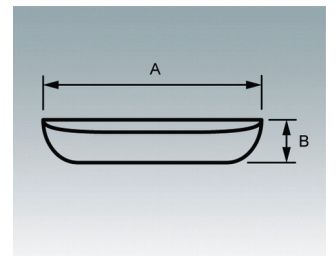

M0000809
Ventilation Louvre
Punch Tools

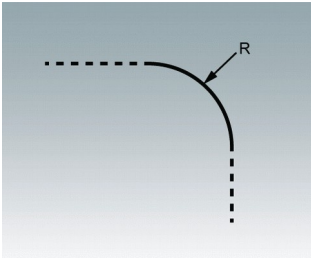

M0000810
Corner Radii
Punch Tools

Subject to technical modification without notice. © OKW Enclosures Ltd