

MET case™

Electronic Enclosures

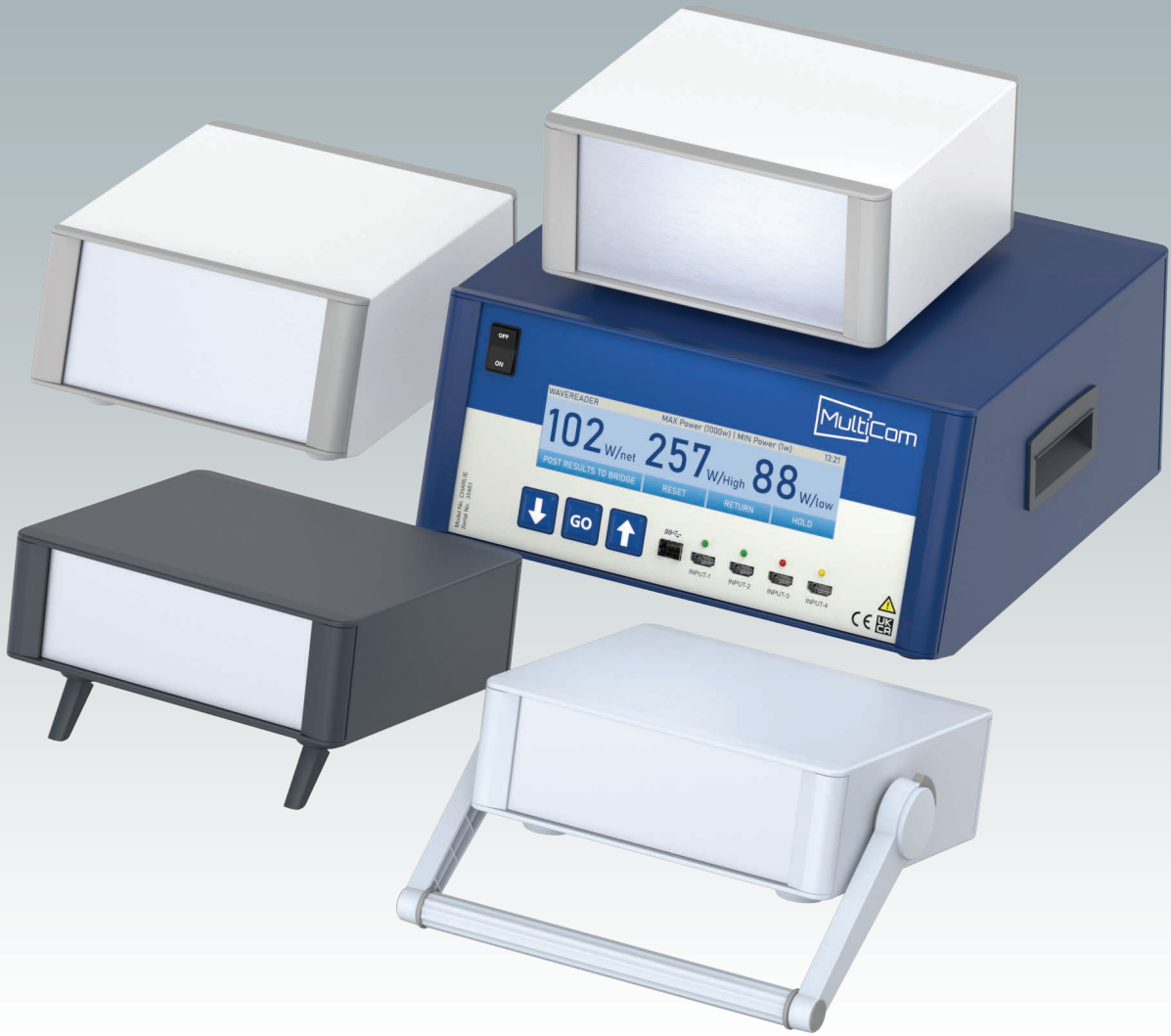

TECHNOMET

Advanced Electronic
Instrument Enclosures

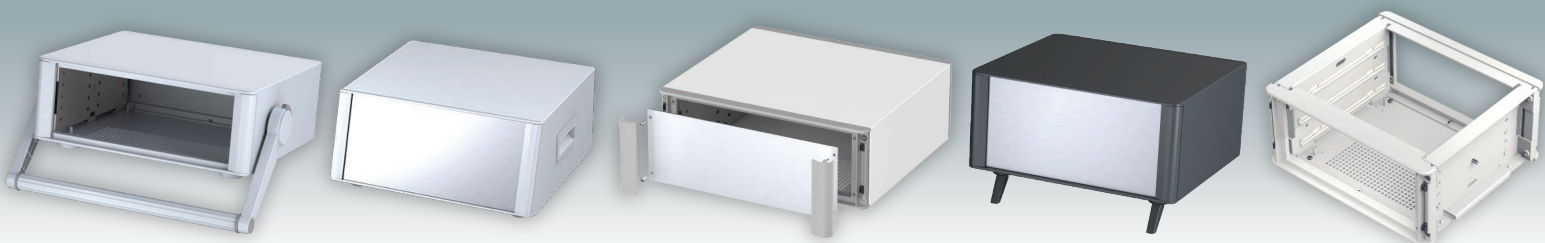

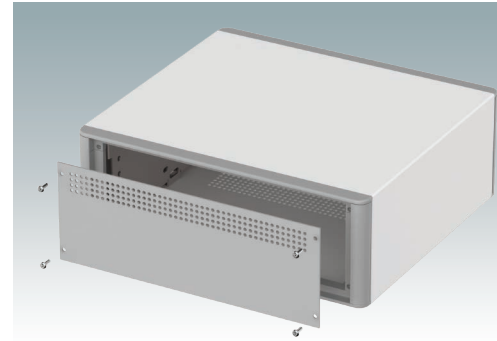
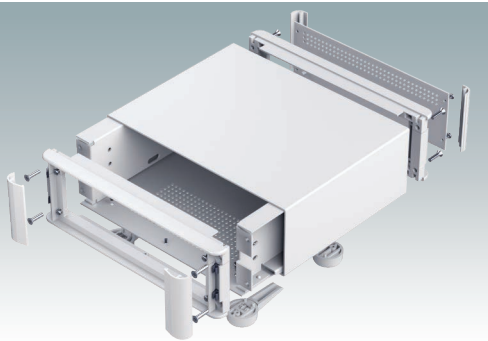
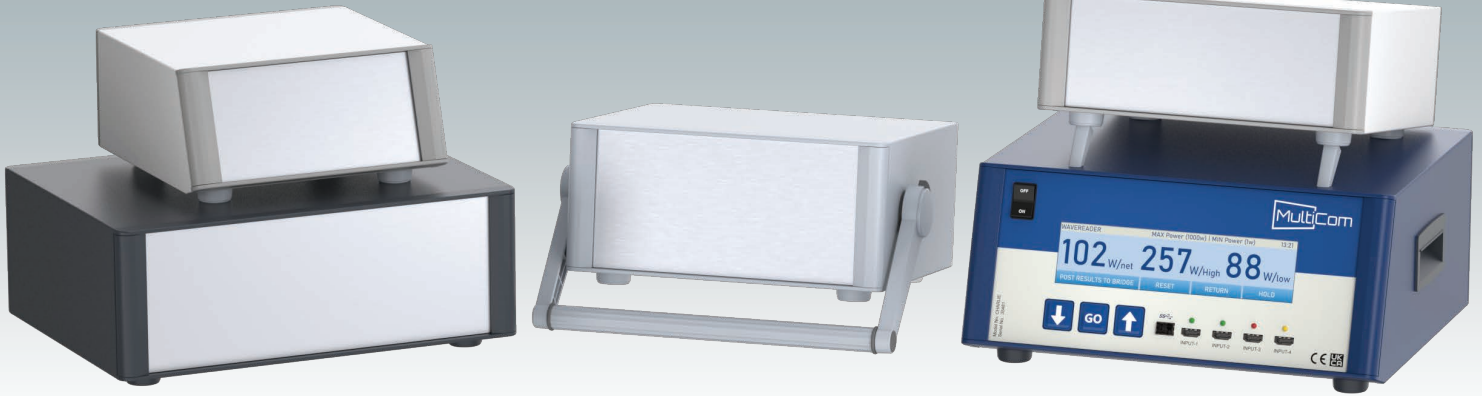

Advanced Electronic Instrument Enclosures

Highly attractive aluminum instrument enclosures for portable electronics. Modern and cohesive design with no visible fixing screws. Diecast front and rear bezels fit flush in the case body. Snap-on front and rear trims hide the case and front panel screws. Ventilation holes in the base and rear panel. Four PCB mounting pillars in the base. Internal chassis for slide-in PCBs. Earth points on all panels. Versions with or without side handles or a bail arm. Supplied with ABS non-slip feet with front tilt legs. Order front panels and PCB guides separately. Order your own fully customized version.

Standard colors

Light gray RAL 7035.
Antracite RAL 7016.
Traffic white RAL 9016.
Traffic gray A RAL 7042.

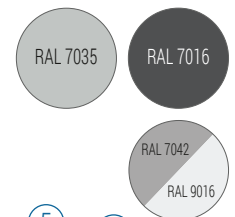

Supply

- ① Top cover
- ② Base/chassis
- ③ Front bezel (x2)
- ④ Front trim (x2)
- ⑤ Rear panel
- ⑥ Rear trim (x2)
- ⑦ Bail arm (Ver. H)
- ⑧ Side handle (x2 Ver. S)
- ⑨ M3 x 8 mm (x10)
- ⑩ M4 x 16 mm (x8)
- ⑪ ABS feet
- ⑫ *Front panel kit

*accessories

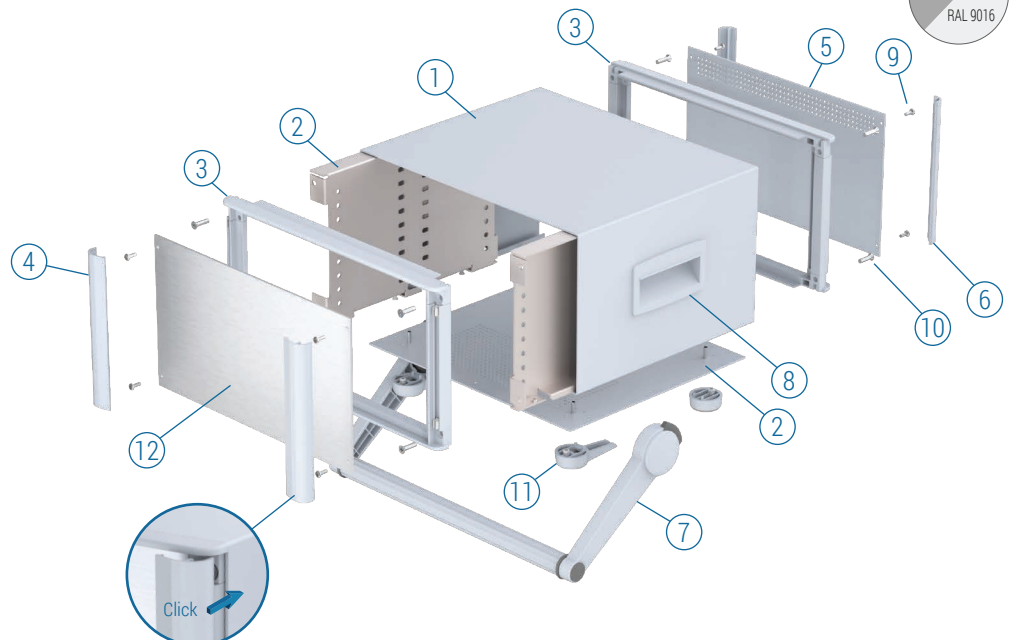

TECHNOMET

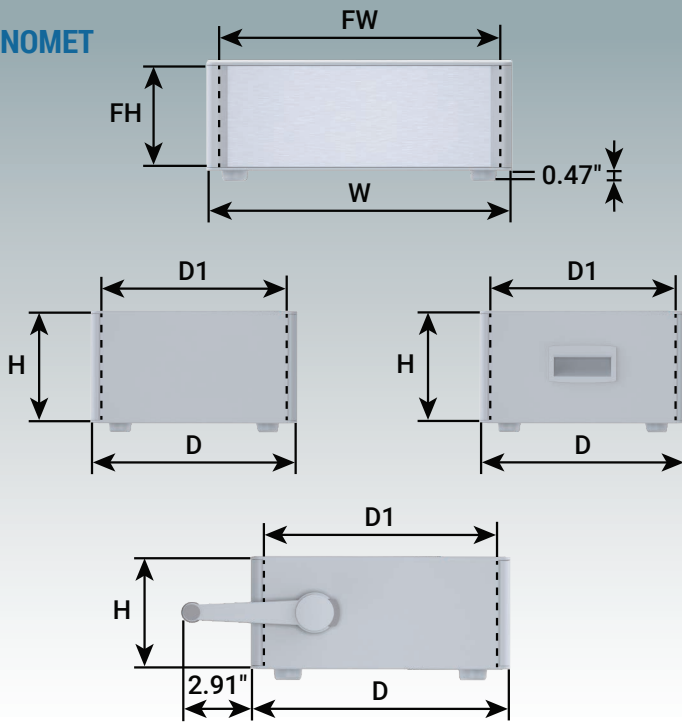

VERSION Rxxx



VERSION RxxxS



VERSION RxxxH

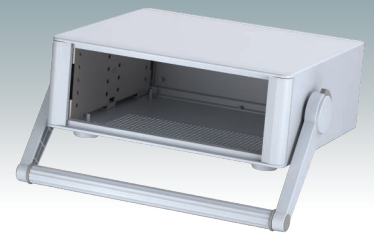

WITHOUT HANDLES

Part No.	Part No.	Part No.	Version	H	W	D	D1	FW Front Panel	FH Front Panel	PCB Width (max.)	PCB Depth (max.)
RAL 7042/9016 ○	RAL 7016 ●	RAL 7035 ○									
M 64 22 026	M 64 22 024	M 64 22 025	R107	2.95"	8.85"	7.87"	7.24"	7.75"	2.59"	7.04"	7.16"
M 64 22 126	M 64 22 124	M 64 22 125	R110	3.93"	8.85"	7.87"	7.24"	7.75"	3.57"	7.04"	7.16"
M 64 27 126	M 64 27 124	M 64 27 125	R210	3.93"	10.83"	9.84"	9.21"	9.72"	3.57"	9.01"	9.13"
M 64 27 226	M 64 27 224	M 64 27 225	R212	4.92"	10.83"	9.84"	9.21"	9.72"	4.55"	9.01"	9.13"
M 64 27 326	M 64 27 324	M 64 27 325	R215	5.90"	10.83"	9.84"	9.21"	9.72"	5.54"	9.01"	9.13"
M 64 35 126	M 64 35 124	M 64 35 125	R310	3.93"	13.78"	10.83"	10.19"	12.67"	3.57"	11.96"	10.11"
M 64 35 226	M 64 35 224	M 64 35 225	R312	4.92"	13.78"	10.83"	10.19"	12.67"	4.55"	11.96"	10.11"
M 64 35 326	M 64 35 324	M 64 35 325	R315	5.90"	13.78"	10.83"	10.19"	12.67"	5.54"	11.96"	10.11"

WITH SIDE HANDLES

Part No.	Part No.	Part No.	Version	H	W	D	D1	FW Front Panel	FH Front Panel	PCB Width (max.)	PCB Depth (max.)
RAL 7042/9016 ○	RAL 7016 ●	RAL 7035 ○									
M 64 27 356	M 64 27 354	M 64 27 355	R215S	5.90"	10.83"	9.84"	9.21"	9.72"	5.54"	9.01"	9.13"
M 64 35 356	M 64 35 354	M 64 35 355	R315S	5.90"	13.78"	10.83"	10.19"	12.67"	5.54"	11.96"	10.11"

WITH BAIL ARM

Part No.	Part No.	Version	H	W	D	D1	FW Front Panel	FH Front Panel	PCB Width (max.)	PCB Depth (max.)
RAL 7016 ●	RAL 7035 ○									
M 64 22 034	M 64 22 035	R107H	2.95"	8.85"	7.87"	7.24"	7.75"	2.59"	7.04"	7.16"
M 64 22 134	M 64 22 135	R110H	3.93"	8.85"	7.87"	7.24"	7.75"	3.57"	7.04"	7.16"
M 64 27 134	M 64 27 135	R210H	3.93"	10.83"	9.84"	9.21"	9.72"	3.57"	9.01"	9.13"
M 64 27 234	M 64 27 235	R212H	4.92"	10.83"	9.84"	9.21"	9.72"	4.55"	9.01"	9.13"
M 64 27 334	M 64 27 335	R215H	5.90"	10.83"	9.84"	9.21"	9.72"	5.54"	9.01"	9.13"
M 64 35 134	M 64 35 135	R310H	3.93"	13.78"	10.83"	10.19"	12.67"	3.57"	11.96"	10.11"
M 64 35 234	M 64 35 235	R312H	4.92"	13.78"	10.83"	10.19"	12.67"	4.55"	11.96"	10.11"
M 64 35 334	M 64 35 335	R315H	5.90"	13.78"	10.83"	10.19"	12.67"	5.54"	11.96"	10.11"

For full 2D drawings and 3D models please see our website.

For front panels and accessories see page 5.

TECHNOMET SL

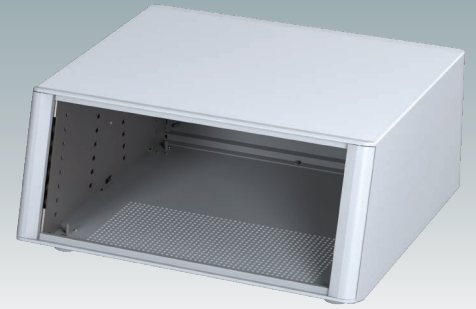
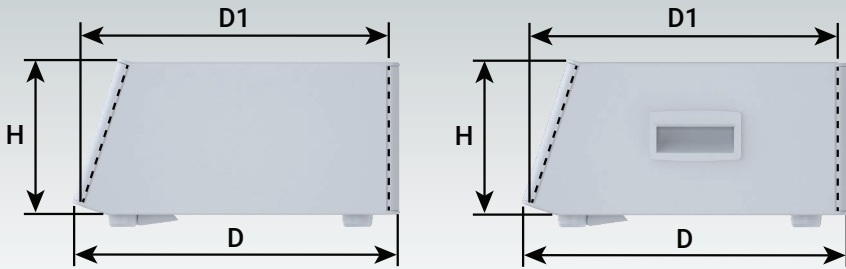

VERSION SLxxx

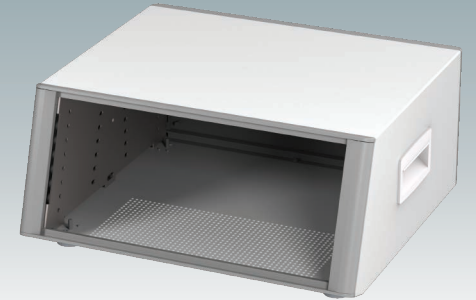

VERSION SLxxxS

WITHOUT SIDE HANDLES

Part No.	Part No.	Part No.	Version	H	W	D	D1	FW Front Panel	FH Front Panel	PCB Width (max.)	PCB Depth (max.)
RAL 7042/9016	RAL 7016	RAL 7035									
M 64 23 126	M 64 23 124	M 64 23 125	SL110	3.93"	8.85"	9.06"	8.41"	7.75"	3.57"	7.04"	8.26"
M 64 28 226	M 64 28 224	M 64 28 225	SL212	4.92"	10.83"	11.22"	10.58"	9.72"	4.55"	9.01"	10.43"
M 64 36 356	M 64 36 354	M 64 36 355	SL315	5.90"	13.78"	12.59"	11.95"	12.67"	5.54"	11.96"	11.81"

WITH SIDE HANDLES

Part No.	Part No.	Part No.	Version	H	W	D	D1	FW Front Panel	FH Front Panel	PCB Width (max.)	PCB Depth (max.)
RAL 7042/9016	RAL 7016	RAL 7035									
M 64 36 326	M 64 36 324	M 64 36 325	SL315S	5.90"	13.78"	12.59"	11.95"	12.67"	5.54"	11.96"	11.81"

Front Panel Kits

Supply:

1 Panel
(2 mm matt anodized aluminum)

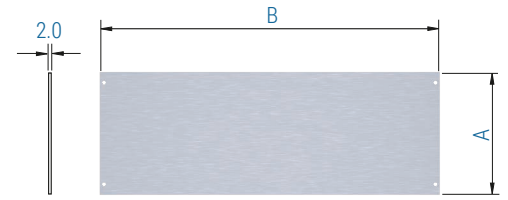

Part No.	Version	A	B
M 64 00 700	R107/R107H	2.59"	7.75"
M 64 00 701	R110/SL110/R110H	3.57"	7.75"
M 64 00 702	R210/R210H	3.57"	9.72"
M 64 00 703	R212/SL212/R212H	4.56"	9.72"
M 64 00 704	R215/R215S/R215H	5.54"	9.72"
M 64 00 705	R310/R310H	3.57"	12.67"
M 64 00 706	R312/R312H	4.56"	12.67"
M 64 00 707	R315/R315S/SL315/SL315S/R315H	5.54"	12.67"

PCB Guides

Four PCB guides are supplied with each case as standard.
You can order additional guides here.

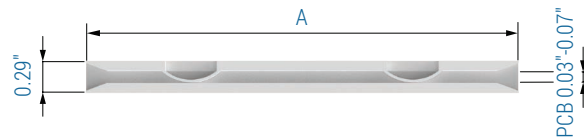

Part No.	A	Technomet Version	Guides per PCB	Guide positions in case
M 64 90 020	140	R107/R107H	2	3
		R110/R110H	2	5
		SL110	2	5
M 64 90 010	102	R210/R210H	4	5
		R212/R212H	4	7
		SL212	4	7
		R215/R215S/R215H	4	9
		R310/R310H	4	5
		R312/R312H	4	7
		R315/R315S/R315H	4	9
SL315/SL315S	4	9		

M 64 90 020

M 64 90 010

M 64 90 010

TECHNOMET | CUSTOMIZED VERSIONS



Order your own customized version

We can supply the TECHNOMET enclosures fully customized to your individual technical specifications.

All external dimensions – height, width and depth – can be modified to ensure your PCB assemblies and equipment will fit exactly.

The enclosures and front panels can be machined with holes and cutouts for fitting displays, keypads, HMI touch panels, control buttons and connections.

Other services include adding inserts and screw bosses; custom colors and finishes; digital and silk-screen printing and engraving.

Having a flexible manufacturing system allows us to offer competitive prices even for small quantities. Do not hesitate to ask us for a quotation.

Our sales team will be very happy to discuss your requirements and help you specify your TECHNOMET enclosures exactly as you need them.

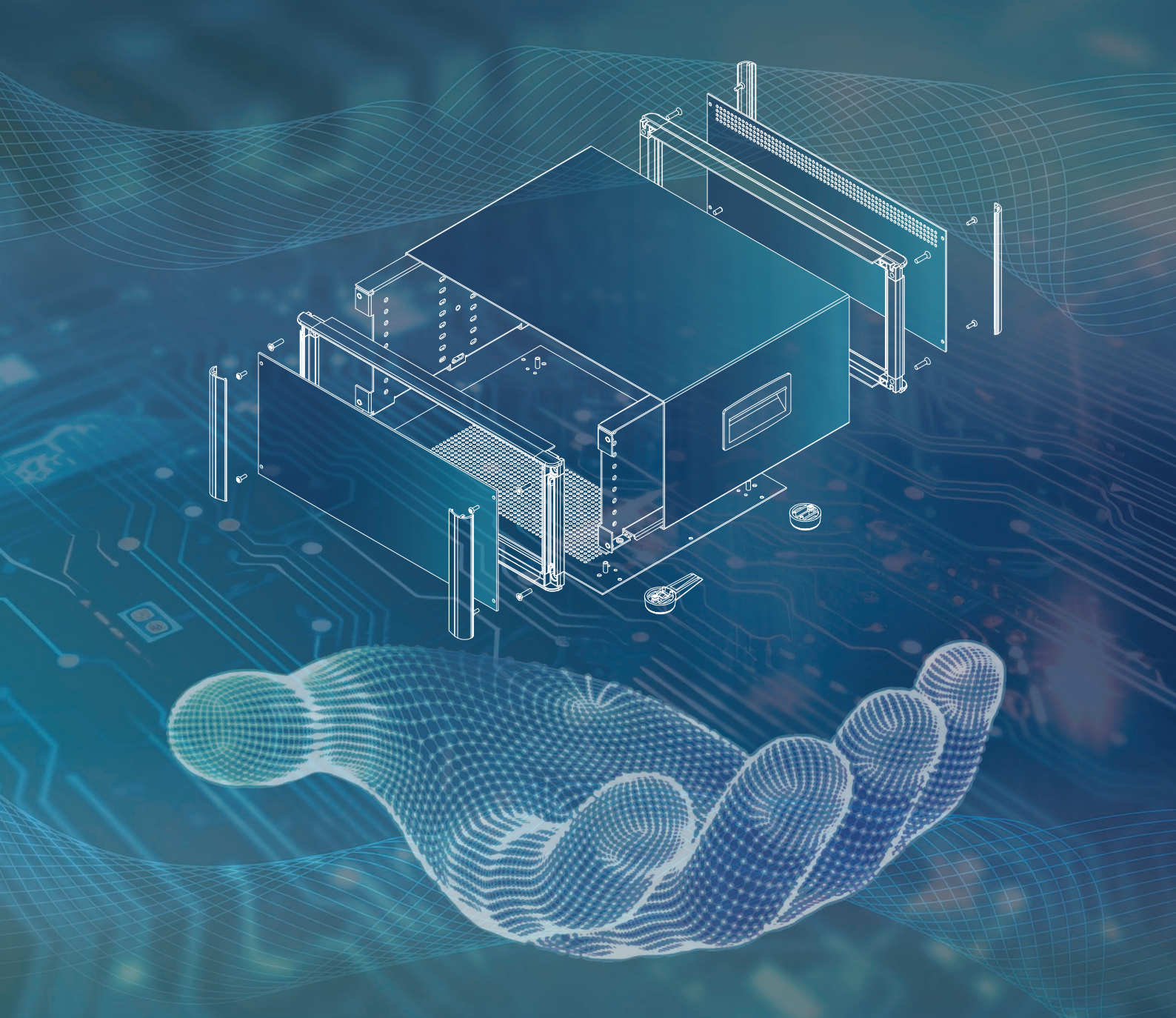

METcase™

MANUFACTURER

Metcase Enclosures
A division of:
OKW Enclosures Ltd.
15 Brunel Way
Segensworth East
Fareham, Hampshire
PO15 5TX
United Kingdom

Telephone: +44 (0) 1489 583858
Email: sales@metcase.co.uk
Website: www.metcase.co.uk

© OKW Enclosures Ltd. All rights reserved
Catalog Edition 1.1 – February 2025.
This catalog will be valid until 31/12/2027.
Subject to technical modifications without notice.
Typographical and other errors do not justify any
claim for damages.
Digital Version: 02/2025e

Presented by:



OKW Enclosures, Inc.
3000 Old Pond Road,
Bridgeville, PA 15017
Phone: (412) 220 9244
Toll Free: (800) 965 9872
Email: sales@metcaseusa.com

www.metcaseusa.com